

**GoKWh**

# **USER MANUAL**

48V 100Ah  
LiFePO4 Battery



Dongguan GoKWh Technology Co., Ltd.  
Version - 2023



## **Important Safety Instructions**

Please save these instructions.

### **DISCLAIMER**

Please read all specifications, usage, storage conditions, and warnings on this document before use. Always adhere to our handling and usage directions for this battery pack. Misuse of batteries can cause the battery to malfunction, degrade and reduce its capacity or life expectancy, overheat, explode, or become a fire hazard. Customers are responsible for the proper use and storage of this battery pack which is outlined on this document. If at any point, the battery excessively overheats, leaks, etc, or does not function as stated, or is visibly damaged; **DO NOT USE**. Please contact our support team for further assistance.

#### **Note (1) :**

The customer is requested to contact GoKWh Technology Co.,Ltd. in advance, if and when the customer needs other applications or operating conditions than those described in this document. Additional experimentation may be required to verify performance and safety under such conditions

#### **Note (2) :**

GoKWh Technology Co.,Ltd. will take no responsibility for any accident when the cell is used under other conditions than those described in this Document.

#### **Note (3):**

GoKWh Technology Co.,Ltd. will inform, in a written form, the customer of improvement(s) regarding proper use and handling of the cell, if it is deemed necessary.

### **WARNINGS**

- 1.** DO NOT immerse the battery in water or allow it to get wet.
- 2.** DO NOT use or store the battery near sources of heat such as a fire or heater.
- 3.** DO NOT reverse the positive (+) and negative (-) terminals.
- 4.** DO NOT connect the battery directly to wall outlets or car cigarette-lighter sockets without proper charging equipment. DO NOT allow exposed ends of cables connected to opposite terminals to touch.
- 5.** DO NOT put the battery into a fire or apply direct heat.
- 6.** DO NOT use the battery if the battery casing has been pierced, broken, cracked, or otherwise visibly damaged. DO NOT forcibly open the battery casing for any reason.

7. Avoid severe physical shock. Do not throw the battery or heavily strike the battery in any way. Do not put excessive pressure or step on the battery.
  8. Never solder anything directly to the battery terminals.
  9. DO NOT attempt to disassemble or modify the battery in any way.
  10. DO NOT place the battery in a microwave oven or pressurized container.
  11. DO NOT use the battery in combination with primary batteries(such as dry-cell batteries) or batteries of different capacity, type or brand.
  12. DO NOT use the battery if it gives off an odor, generates heat, becomes discolored or deformed, or appears abnormal in any way. If the battery is in use or being recharged, remove it from the device or charger immediately and discontinue use.
  13. DO NOT use or store the battery where is exposed to extremely hot, such as under window of a car in direct sunlight in a hot day. Otherwise, the battery may be overheated. This can also reduce battery performance and/or shorten service life.
  14. If the battery leaks and electrolyte gets in your eyes, do not rub them. Instead, rinse them with clean running water and immediately seek medical attention. If left as is, electrolyte can cause eye injury.
- 

## **Table of Contents**

- SCOPE OF APPLICATION
  - TECHNICAL PARAMETER
  - RS485-A RS485-B Description
  - LED DISPLAY
  - SET THE RS485 AND CANBUS PROTOCOLS OF THE BMS TO THE INVERTER THROUGH THEUPLCD DISPLAYSCREEN
  - DESCRIPTION OF COMMUNICATION AND PC SOFTWARE
  - DIAL SWITCH ADDRESS SETTING
  - STORAGE ANDOTHERS
  - WARRANTY
- 

## **1 SCOPE OF APPLICATION**

This product specification describes the product performance index, maintenance and danger warning of the energy storage battery pack produced by Dongguan GoKWh Technology Co., Ltd. This User Manual is applicable to 48V 100Ah/200Ah/300Ah Battery. If users need more technical support or any other requirements, they can contact the customer service center or technical center of GoKWh Technology Co., Ltd.

## 2 TECHNICAL PARAMETER

Model	48100	Remark
<b>Basical</b>		
Cell Type	LiFePO4 Prismatic	
Dimensions	440*430*222mm	
Combination Method	16S1P	
Weight	48kg	
Case Material	Cold Rolled Steel(SPCC)	
<b>Electrical</b>		
Typical Capacity	100AH	at25°C,0.2C Discharging
Minimum Capacity	≥95Ah	
Nominal Voltage	51.2V	
Nominal Energy	5120Wh	
Discharge Cut-off Voltage	≥40V	
Charging Cut-off Voltage	≤58.4V	
Internal Impedance	≤60mΩ	Under 20±5°C Environment Temperature , the Usage Frequency of Fully Charge( 1KHz) , Use AC Internal Impedance test machine to test
Recommend Max Charging Current	≤50A	Ampere-meter ,Maximum allowable charging current of the battery pack
Max Discharging Current	≤100A	Maximum discharge current allowed by the battery pack
Standard Charge Current	20A	
Standard Discharge Current	40A	
Internal Resistance	≤30 mΩ	
<b>Performance</b>		
Cycle Life	≥6000 Cycles	
Service Life	10 Years	
Protection	IP20, Built-in BMS	
<b>Temperature Range</b>		
Charge	0~45°C (32~113°F)	
Discharge	-20~60°C (-4~140°F)	
Storage	-20~25°C (-4~77°F)	Recommend (25±3°C) ; ≤90%RH storage moisture range.

### 3 APPEARANCE AND STRUCTURAL DIMENSIONS

There shall be no such defect as scratch, bur and other mechanical scratch, and the connector should be no rust dirt. The structure and dimensions see attached drawing of the product.

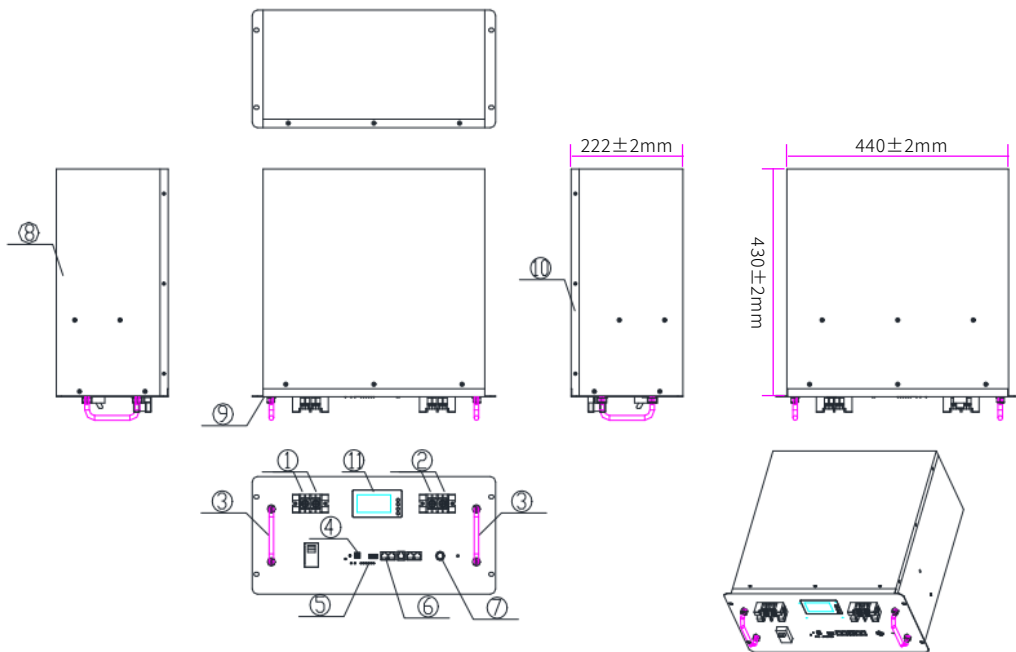

1	Positive Terminal	7	On-off Switch
2	Negative Terminal	8	Main Box
3	Handle	9	Front Cover
4	Dial Switch	10	Box Cover
5	Battery Indicator Light	11	LED Display
6	Communication Interface RS485/CAN		

## 4 RS485-A, RS485-B Description

Communication with host computer

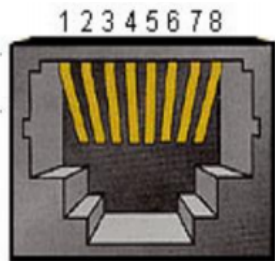

RS485- using 8P8C vertical RJ45 socket	
RJ45 Pin	Definition Description
1、8	RS485-B
2、7	RS485-A
3、4、5、6	GND

## 5 LED DISPLAY

Start running: LED starts from 16.66% power lamp

Table 1 LED working status indication

State	Normal/Alarm /Protection	RUN1	RUN2	ALM	LED Battery Indicator Light						Description	
		●	●	●	●	●	●	●	●	●		
Shutdown	Dormancy	Off	Off	Off	Off	Off	Off	Off	Off	Off	Off	All Turn Off
Standby	Normal	On	Flashing 1	Off	Based on battery energy						Standby state	
	Alarm	On	Flashing 1	Flashing 3							Module in Low Voltage	
Charging	Normal	On	On	Off	(The highest LED of the electrical indicator light flashes 2)						The highest battery LED flashes (flashing 2), and the overcharge alarm ALM does not flash	
Charging	Alarm	On	On	Off								
	Overcharge protection	On	On	Off	On	On	On	On	On	On	On	If there is no mains power, the indicator
	Temperature, overcurrent, failure protection	On	Off	On	Off	Off	Off	Off	Off	Off	Off	Stop charging
Discharge	Normal	On	Flashing 3	Off	Based on battery energy							
	Alarm	On	Flashing 3	Flashing 3								
	Under voltage protection	On	Off	Off	Off	Off	Off	Off	Off	Off	Off	Stop discharging
	Temperature, overcurrent, short	On	Off	On	Off	Off	Off	Off	Off	Off	Off	Stop discharging
Lose efficacy		Off	Off	On	Off	Off	Off	Off	Off	Off	Off	Stop charging and discharging

Table 2 Description of capacity indication

State		Charging						Discharging					
Capacity indicator light		L6	L5	L4	L3	L2	L1	L6	L5	L4	L3	L2	L1
Energy (%)	0~16.6%	Off	Off	Off	Off	Off	Flashing 2	Off	Off	Off	Off	Off	On
	16.6~33.2%	Off	Off	Off	Off	Flashing 2	On	Off	Off	Off	Off	On	On
	33.2~49.8%	Off	Off	Off	Flashing 2	On	On	Off	Off	Off	On	On	On
	49.8~66.4%	Off	Off	Flashing 2	On	On	On	Off	Off	On	On	On	On
	66.4~83%	Off	Flashing 2	On	On	On	On	Off	On	On	On	On	On
83%~100%	Flashing 2	On	On	On	On	On	On	On	On	On	On	On	On
Running indicator light RUN1	●	On						On					
Running indicator light RUN2	●	On						Flashing (flashing 3)					

Description of LED flashing: Flashing 1, on for 0.3s, off for 3.7s; Flashing 2, on for 0.5s, off for 0.5s; Flashing 3, on for 0.5s, off for 1.5s.

## 6 SET THE RS485 AND CANBUS PROTOCOLS OF THE BMS TO THE INVERTER THROUGH THE UPLCD DISPLAY SCREEN

Select PackSet option

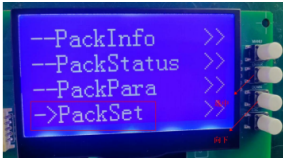

Select the protocol type that needs to be set, namely RS485 or CANBUS

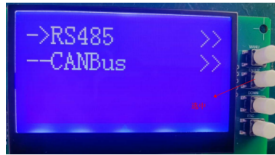

Set the corresponding protocol type

Select the corresponding protocol using the DOWN button

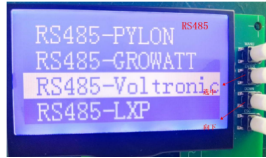
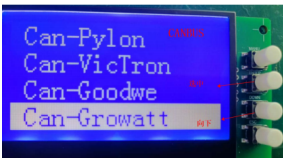

Click the Enter button to select

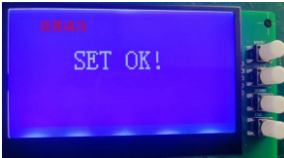
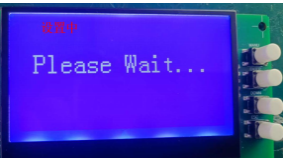

## 7 DESCRIPTION OF COMMUNICATION AND PC SOFTWARE

### Communication description

#### RS485 1 communication, RS485 2 communication

The BMS uses RS485 communication to communicate with the designated upper computer through a special communication box. The baud rate is 19200bps by default. Thus, various information of the battery can be viewed at the upper computer terminal, including battery voltage, current, temperature, status, SOC, SOH and battery production information.

Parameter settings and corresponding control operations can be carried out to support the program upgrade function. Support the customer protocol (This upper computer is applicable to the PC of Windows series platform.)

## 8 DIAL SWITCH ADDRESS SETTING

When the battery pack is used in parallel, different PACKs can be distinguished by hardware address, and the hardware address of each PACK in the whole battery stack is unique. The hardware address can be set in turn through the dial switch on the board, with 1, 2, 3, 4, dials. Refer to the following table for the definition of switches.



Adress	Setting&Explain				
	1	2	3	4	
0000(0)	OFF	OFF	OFF	OFF	When using 485 communication alone, select "MASTER (0000)", act as the host during parallel communication
0001(1)	ON	OFF	OFF	OFF	Select "SLAVE1 (0001)" for single 485 communication
0010(2)	OFF	OFF	ON	OFF	Select "SLAVE2(0010)" for single 485 communication
0011(3)	ON	OFF	ON	ON	Select "SLAVE3(0011)" for single 485 communication
0100(4)	OFF	ON	OFF	OFF	Select "SLAVE4(0100)" for single 485 communication
0101(5)	ON	ON	OFF	ON	Select "SLAVE4(0101)" for single 485 communication
0110(6)	OFF	ON	ON	OFF	Select "SLAVE4(0110)" for single 485 communication
0111(7)	ON	ON	ON	ON	Select "SLAVE4(0111)" for single 485 communication
1000(8)	ON	OFF	OFF	OFF	Select "SLAVE4(1000)" for single 485 communication
1001(9)	ON	OFF	OFF	ON	Select "SLAVE4(1001)" for single 485 communication
1010(10)	ON	OFF	ON	OFF	Select "SLAVE4(1010)" for single 485 communication
1011(11)	ON	OFF	ON	ON	Select "SLAVE4(1011)" for single 485 communication
1100(12)	ON	ON	OFF	OFF	Select "SLAVE4(1100)" for single 485 communication
1101(13)	ON	ON	OFF	ON	Select "SLAVE4(1101)" for single 485 communication
1110(14)	ON	ON	ON	OFF	Select "SLAVE4(1110)" for single 485 communication
1111(15)	ON	ON	ON	ON	Select "SLAVE15(1111)" for single 485 communication

## 9 STORAGE AND OTHERS

### Long Time Storage

If stored for a long time (don't used, exceed three months), the cell should be stored in drying and cooling place. The PACK is to be stored in a condition that the temperature of  $23 \pm 2^{\circ}\text{C}$  and the humidity of 45%- 75%. Long-term use of unused batteries to recharge every 3 months. Ensure that the battery voltage is within the above range.



# **10 WARRANTY**

## **10 Year Warranty for After-Sales**

The LiFePO<sub>4</sub> batteries come with 10-year manufacturer's defect warranty from the date of battery purchase.

\*Note: All batteries are fully tested before being shipped. Warranty is a guarantee against manufacturer defects only.

GoKWh warrants this battery to be free from manufacturer defects for 10 years. If for some improbable circumstance the battery is defective, we will replace the battery.

The following situation is not covered by the warranty:

Batteries that have been poorly maintained, incorrectly charged, reversed polarity, improperly installed, stored and used in excessive heat, physical damage, fire, freezing, water damage, tampering, damage to terminals, failure to maintain proper battery charge or use in excess of rated charge/discharge cycles.

Loss or damage due to force majeure or external causes, misuse, accident, negligence, unauthorized modification or repair.

Warranties apply only to the original owner and are not transferable. We will verify your purchase before processing any warranty claims or returns.

The buyer intentionally conceals or fails to cooperate in providing usage information.

GoKWh has a team of technicians to provide technical support if needed. Proof of purchase and your usage will be requested. The customer is responsible for shipping costs. If we deem the product manufacturer defective, we will cover the replacement shipping costs.

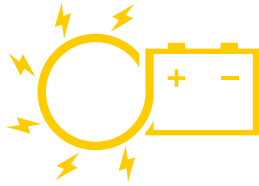

# GoKWh

**Make Your Daily Power Up.**

 hi @ gokwh.com

 +86-18566184618

 gokwh.com

 Puxin Road, Tangxia Town, Dongguan, Guangdong, China

Dongguan Gokwh Technology Co , Ltd .